

*Craftsman*  
MARINE

# CM2.16 & CM3.27

ENGINE MANUAL

CRAFTED WITH CRAFTSMAN MARINE

PROPULSION



**Note:**

This manual applies to model CM2.16 and model CM3.27. Therefore, it can happen that a drawing or picture is not always an exact referral to the engine that you have purchased. Please read this manual carefully before commissioning the engine. Improper use of this engine may cause accidents and all warranty conditions may become invalid.

In this manual you will also find detailed instructions of how and how regularly the various components of your engine must be serviced. This engine must be used exclusively in accordance with the prescription given in the General Conditions of Sale and Supply.

In the case of deviating use the manufacturer does not accept any responsibility whatsoever for resulting damage. This type of risk is to be borne exclusively by the user.

Correct and proper use also implies strictly adhering to the prescriptions of operation, maintenance and repair. Only such persons, who are acquainted with the operation, the maintenance and the repair of your engine, and who are fully aware of any danger involved, should be allowed to work at your engine.

For that reason, always have your engine serviced, maintained and repaired by an authorized CRAFTSMAN MARINE dealer.

In the case of modifications of the engine, which have not been previously approved by Craftsman Marine in writing, the responsibility of the manufacturer for any resulting damage is immediately rendered null and void.

Modifications of the injection and distribution system also form part of the aforementioned exclusion of the manufacturer's warranty.

Moreover, they may affect the performance of the engine and the exhaust gas emission in a negative fashion. It may be possible that the fulfillment of the legal prescriptions regarding the emission of exhaust gases, aiming at the protection of the environment, is no longer guaranteed in that case.

**Disclaimer**

The specifications and the descriptions in this instruction manual were correct at the time of going to press. However, Craftsman Marine is continuously striving after the improvement of its products and therefore reserves the right to modify - at all times and without prior notification - product specifications and instruction manuals.

Dear owner of this engine,

We should like to thank you very much indeed for your decision to procure a marine diesel engine, made by Craftsman Marine.

Provided you will make proper use of it and take care of adequate maintenance, this engine will serve you faithfully and trouble-free, for many years to come.

This instruction manual informs you about the control, the maintenance and the inspection of the Craftsman Marine diesel engines, models CM2.16 and CM3.27.

Please store this manual in an accessible place.

Should you have any further questions after having read this manual, we shall be delighted to be of service.

Craftsman Marine B.V.

This page will provide you with a survey of all warning pictograms, used throughout this manual. Notes referring to safety issues show this symbol:



### **DANGER ATTENTION**

Please adhere strictly to the recommendations in this chapter and instruct anybody else, who may be operating or servicing the engine, to do likewise. These are the safety recommendations:

- Never touch any moving parts when the engine is running.
- When in operation the engine (or certain parts thereof) may become very hot. Do not ever touch these parts and be very careful with flammable products in the neighbourhood of the engine.
- When checking upon or adjusting any parts, or when checking or filling lubricants or cooling liquids, make sure that the engine is stopped.
- Do not open the filler cap on the expansion tank or on the heat exchanger unless the engine is completely cooled down.
- Maintenance and service to the engine must only be provided by experienced people, using suitable tools. If possible entrust only an authorized Craftsman Marine dealer to do such work.



**Pay attention to the symbols and read the instructions in the text.**



**Attention**  
(especially with a view to a safety risk for man or material)

## Table of contents

<b>Disclaimer</b>	<b>3</b>	<b>5 Maintenance</b>	<b>18</b>
<b>Safety</b>	<b>4</b>	<b>6 Maintenance and inspection</b>	<b>19</b>
<b>1 Standard scope of supply</b>	<b>6</b>	Topping up the lubrication oil	19
<b>2 Product description</b>	<b>8</b>	Check-up of coolant level	20
Service side	8	Replace cooling liquid	20
Starter motor side	9	Checking of the cooling water strainer	21
<b>3 Prior to commissioning the engine</b>	<b>11</b>	Draining of the water separator	22
Engine lubrication oil	11	Check the flexible engine mountings	27
Gearbox	12	Inspection of the V-belt	28
Cooling liquid	13	<b>7 Winter storage</b>	<b>29</b>
Standard panel type ALFA10E/ALFA20E	14	<b>8 Preparations for the new season</b>	<b>31</b>
<b>4 Engine operation</b>	<b>16</b>	<b>9 Problems and solutions</b>	<b>32</b>
Check first	16	<b>10 Technical data</b>	<b>36</b>
The starting procedure	16	<b>11 Lubricants and cooling liquids</b>	<b>38</b>
Monitoring lights oil pressure and battery charging current	17	<b>12 Overall Dimensions</b>	<b>40</b>

# 1 Standard scope of supply

- Engine instrument panel, type Alfa 10E or type Alfa 20E
- Engine cable loom with fuse and multi-plugs
- Connection parts for the push-pull cables
- Four flexible engine mountings
- Sump pump

Accessory equipment, required for a perfect engine installation (optional):

- Fuel filter/water separator in the fuel supply line

For a complete list of supply take a look at our website  
[www.craftsmanmarine.com](http://www.craftsmanmarine.com)

# General maintenance directives

By carefully adhering to the following recommendations, you will be sure of the best possible conditions to operate your engine, resulting in a long life span, excellent performance and fuel economy.

- Have the maintenance procedures regularly executed, as mentioned in this manual.
- Prior to starting the engine, always verify the correct level of the various fluids.
- All year long, use a good quality anti-freeze product, protecting your engine against corrosion and frost damage. Please see page 43 for the specifications of the cooling liquid.
- Do not ever put the engine into operation without a properly functioning thermostat, so as to avoid overheating of the engine.
- Always use the correct quality of lubricants, as specified on page 13 of this manual.
- Always use good quality diesel fuel, free from water and /or other impurities.
- Switch-off the engine immediately if the monitoring light(s) of oil pressure, fresh water temperature, raw water temperature and/or battery charging control light up.



## 2 Product description

Service side

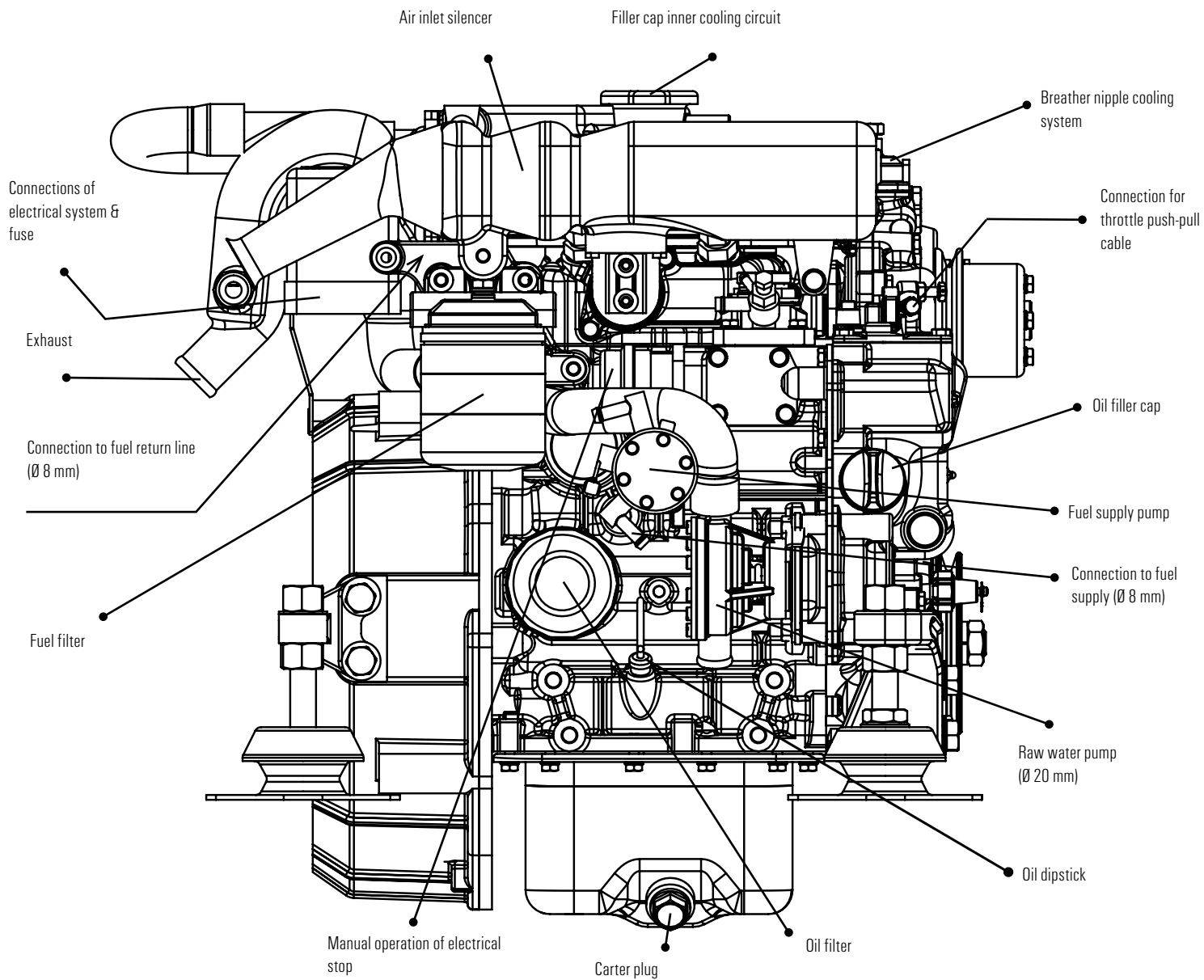



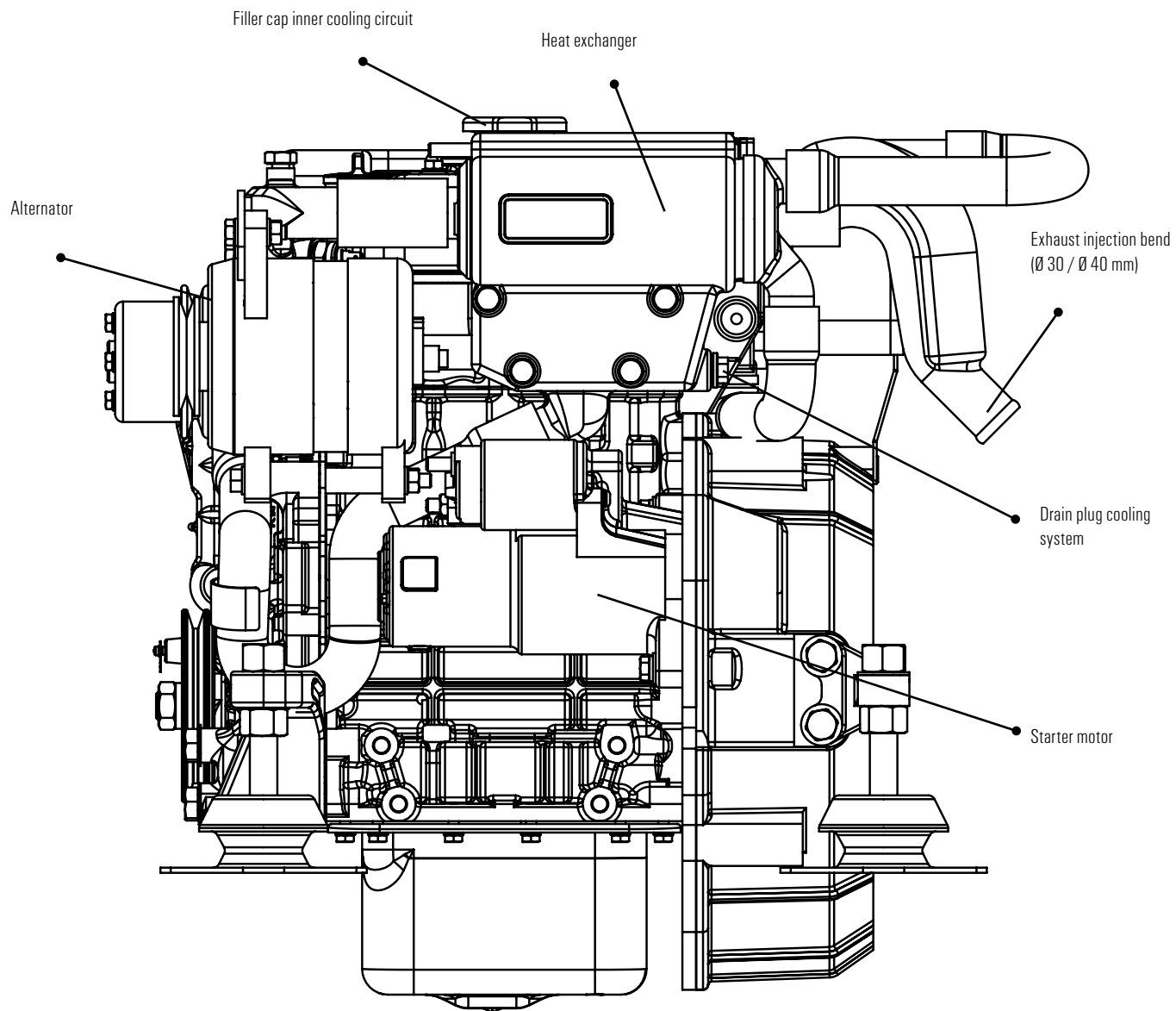

## 2 Product description

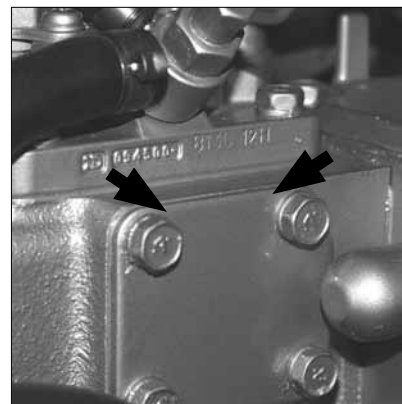
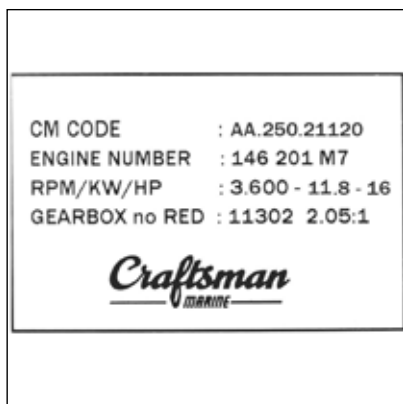

### Identification tag

The Craftsman Marine identification tag is the place to find the engine model, the serial number and a few more data concerning your engine.

### Position of the identification tag

The Craftsman Marine identification tag is located on top of the rocker cover, next to the filler cap for the inner cooling system.

### Mitsubishi engine serial number

The Mitsubishi engine serial number is engraved into the engine block to the starboard side.

The identification tag of the 2-cilindre engines is located on the gearbox housing.



You will need this information if and when you have to order spare parts, or if you want to correspond with our service department.

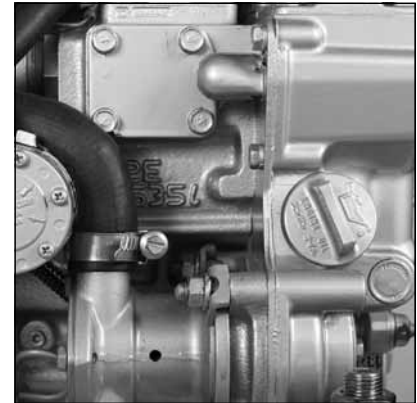
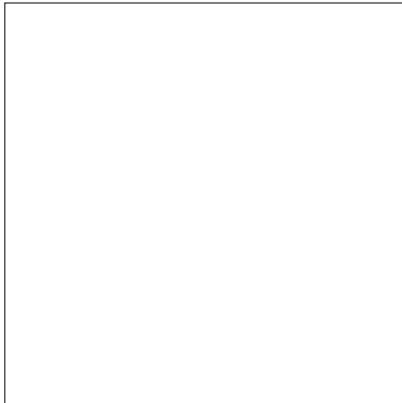

### Engine lubrication oil

The Craftsman Marine diesel engines are supplied without lubrication oil.

Before commissioning the engine for the first time, it must be filled with 5 liters of lubrication oil for diesel engines, with following specifications:

Type: 15W40  
API: CD, CE or CF4  
CCMC: D4 or D5

The engine can be filled with oil through the filler cap on the rocker cover or through the filler pipe at the front of the engine.

A second filler cap is located at the starboard side, next to the engine identification tag.



When the filling of oil is completed, check with the dipstick whether the level of lubricating oil is correct.

### 3 Prior to commissioning the engine

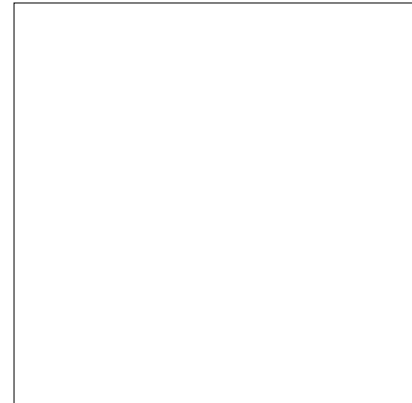
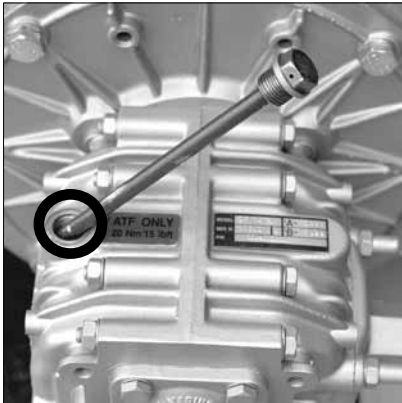

#### **Gearbox**

The gearbox is located at the rear of the engine and it must also be filled with the correct type and quantity of lubricant.

Craftsman Marine diesel engines are supplied with gearboxes of several brands and types.

For the ZF-Hurth and Technodrive brands the types and quantities are specified here below: Please consult the appropriate instruction manuals in the case of other gearbox makes and models.

Here it is shown how the gearbox can be filled up with its lubricant. When the filling is completed, verify with the dipstick whether the correct level of fluid is obtained.

#### **ZF Hurth**

Type ZF 10: 0,35 liter ATF

Type ZF 12: 1,1 liter ATF

#### **Technodrive**

Type TMC40: 0,20 liter SAE 20/30

Type TMC60: 0,80 liter SAE 20/30

(ATF: Automatic Transmission Fluid, type A, suffix A)

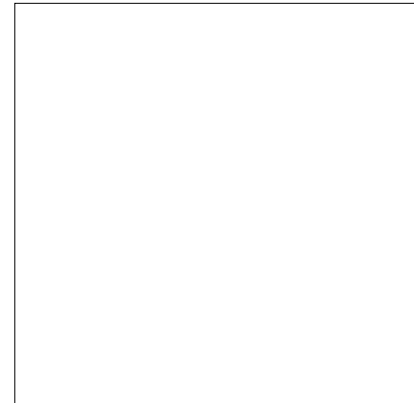
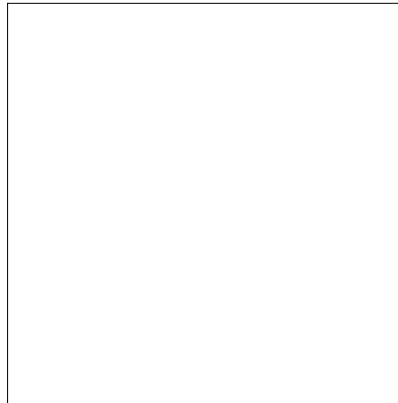

### Cooling liquid

Prior to commissioning the engine for the first time, the inner cooling circuit must be filled with cooling liquid.

In order to do so, the filler cap on top of the heat exchanger housing must be removed.

Alternatively: if and when an expansion tank is fitted, remove the cap on top.

The cooling system must be filled with 6,5 liters of cooling liquid. You can fill the system with a ready-to-use product, or prepare a mixture of 40% anti-freeze (on the basis of ethylene-glycol) and 60% of clean tap water.

Fill the system to about 1 cm below the bottom of the filler pipe. The system will breathe automatically. Do not forget to put the filler cap in place again and tighten the breather bolt.

Once the engine being commissioned and having run for the first time, verify again the level of the cooling liquid and top up, if necessary.



Never fill the cooling system with sea water! Never fill the cooling system with sea water!

### 3 Prior to commissioning the engine

#### Standard panel type Alfa10E / Alfa20E

1. Revolution counter / hour counter
2. Voltmeter
3. Starter switch
4. Monitoring light temperature raw water
5. Monitoring light oil pressure engine
6. Monitoring light cooling liquid temperature
7. Sensor for automatic backlight dimming
8. Monitoring light charging current
9. Monitoring light pre-heating system
10. Low oil pressure gearbox

#### Optional

The voltmeter may be replaced by a temperature gauge

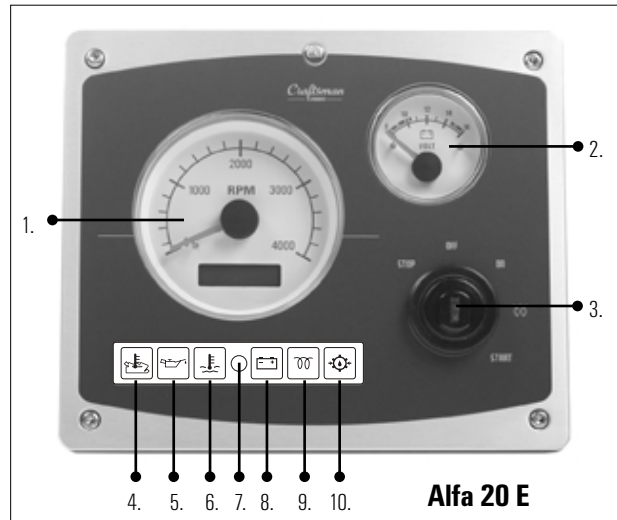

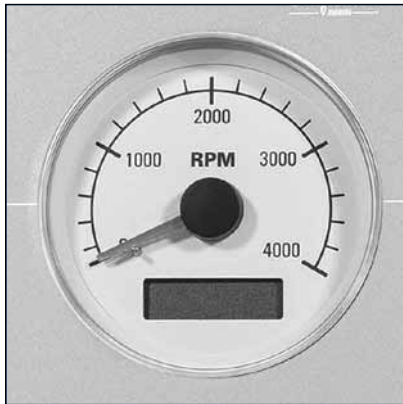

### Revolution counter / hour counter

The revolution counter indicates the number of the engine's revolutions per minute. When underway, do not let the engine run at maximum revolutions during a prolonged period of time. Also, do not have the engine idling for more than a few minutes and never run the engine at full throttle, in order to heat it up quickly.

The hour counter indicates the total running time of the engine in hours.

Idling speed of the engines CM 2.16 and CM 3.27: 850 rpm.

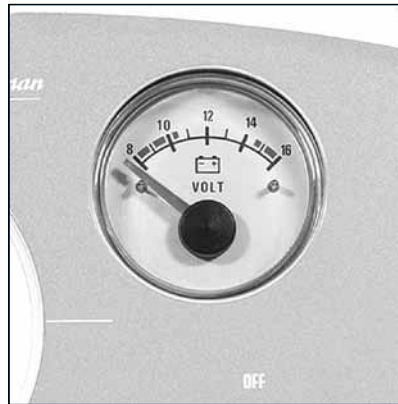

### Voltmeter

The voltmeter shows the voltage of the battery. When the engine is stopped and the starter switch turned to 'on' or 'pre-heat' the battery voltage must be about 12 Volt. When the engine is running the figure must read between 12 and 14.5 Volt.

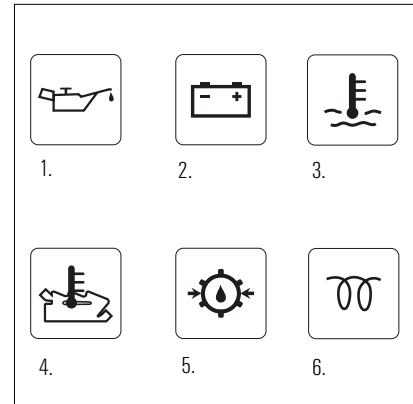

### Monitoring lights

The instrument panel features six monitoring lights for, respectively:

1. oil pressure
2. battery charging current
3. temperature inner cooling circuit
4. temperature raw water
5. low oil pressure gearbox
6. pre-heating

These monitoring lights, except the pre-heating monitor, are connected to a buzzer. If the buzzer becomes audible when the engine is running, a problem has occurred to one of the functions described here above.



In that case, stop the engine IMMEDIATELY!

## 4 Engine operation



### Check first

Always check on following points, before starting the engine:

- Oil level
- Coolant level
- Is the raw water seacock opened?
- Is the main electrical switch 'on'?
- Is the gearbox lever in the neutral position?

### The starting procedure

1. Prior to starting the engine, position the throttle lever at half of its travel, without engaging the gearbox.
2. Turn the key from the 'off' position one step further to the right, to the 'on' position. The monitoring lights for oil pressure, charging currents and pre-heating will light up and the buzzer is audible.
3. From the 'on' position turn the key one step further to the right, to the 'pre-heating' position. Now only the pre-heating monitoring light is burning. Keep the key about 6 seconds in this position (at an ambient temperature of 15° C or more).
4. The turn the starter key one step further to the right, to the 'start' position and release the key as soon as the engine springs to life; the key will return automatically to the 'on' position, where it will remain parked as long as the engine is running. Have the engine running at idling revolutions during a short period of time, so that the engine will warm-up to some extent.

### Note:

The time required for pre-heating the engine is determined by the ambient temperature. The lower the temperature, the longer the pre-heating procedure will take. At freezing temperature, it may take as long as 20 seconds; and up to 10 seconds at temperatures of up to 7 degrees. Do not pre-heat the engine any longer than 1 minute maximum.



Stop the starting procedure if the engine does not come to life within 10 seconds. Release the key and wait till the starter motor has come to a complete stand-still before giving it another try. Do not have the starter motor running during more than 30 seconds, in order to avoid damage by overheating.



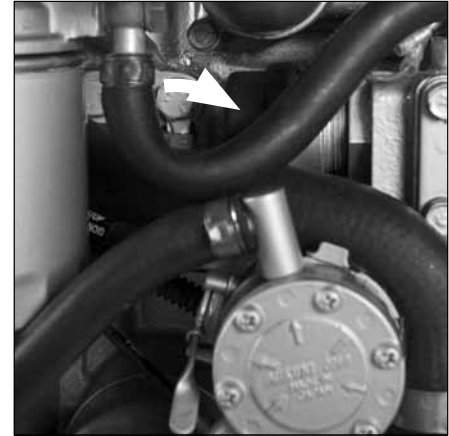
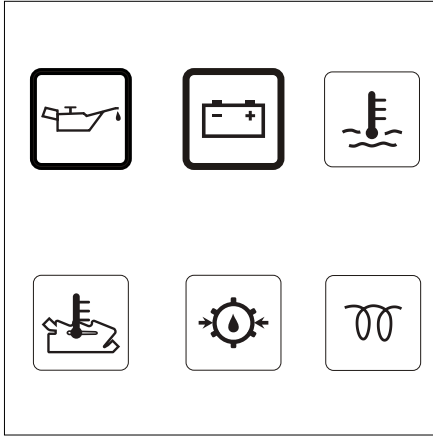

**Monitoring lights oil pressure and battery charging current**

Make sure that the monitoring lights for oil pressure and charging current are extinguished and that cooling water is coming out of the exhaust line. If not so, stop the engine IMMEDIATELY.



Never turn the electric main switch to the 'off' position when the engine is running.

Also: do not turn the starter switch to the 'start' position when the engine is running. This may cause serious damage to the starter motor.

**Electric engine stop**

Before stopping the engine, shift the throttle lever back to its neutral position, place the gearbox lever into the neutral position and let the engine idle during a few moments. Turn the starter switch to the far left position of 'stop'. After a long trip it is recommended to have the engine idling for a few minutes, before putting it to full stop.

When the engine has stopped, turn the key one step to the right, to the 'off' position.

Close the seacock of the raw water inlet and turn the main electrical switch to the off position, if the engine will not be used during a prolonged period of time.

**Manual stop**

Should the engine not respond to the stop command by means of the starter key, keep the black button on top of the fuel lift pump depressed during a few seconds. The engine will stop immediately, by lack of fuel supply.

## 5 Maintenance

In order to ensure a long life span of your engine, it is imperative to adhere to the following directives pertaining to the periodical maintenance of the engine and its components. In the case of inadequate maintenance, serious damage can be caused to the engine and no warranty claim can be accepted by the manufacturer. These are the jobs to be performed:

### Recording of data for verification

#### Every 10 hours or daily before starting

- Check level of engine lubricating oil (page 19)
- Check level of cooling liquid (page 20)
- Check cooling water strainer for blockage of the water flow (page 21)

#### After the first 50 hours of operation

Ask your dealer to execute this maintenance job:

- Drain water from the fuel filter/water separator (page 22)
- Change engine lubrication oil (page 23)
- Replace oil filter (page 23)
- Change lubricating fluid in gearbox (page 25)
- Replace fuel filter (page 26)
- Verify idling revolutions and adjust if necessary (page 15)

#### After every 100 hours of operation (or at least once a year)

Ask your dealer to execute this service job:

- Drain water from the fuel filter/water separator
- Change engine lubrication oil
- Replace oil filter
- Verify level of lubricating fluid in gearbox
- Replace fuel filter
- Check batteries, cables and connections

#### After every 500 hours of operation (at least once a year)

Have your dealer check and execute the following:

- Verify the tolerance of the valves
- Replace the fuel filter
- Change the oil in the gearbox
- Clean the filter, which is located just before the fuel lift pump
- Verify the flexible engine mountings to have the correct compression and adjust if necessary
- Check all hoses and hose connections for leaks
- Verify the tension of the V-belt

#### After every 1000 hours of operation (or at least once every two years)

Have your dealer check and execute the following:

- Verify the proper functioning of the raw water pump
- Replace the cooling liquid in the inner cooling circuit

If necessary:

- Bleed the fuel system (page 22)
- Verify the number of revolutions when idling (page 15)



Only service the engine when it is not running!

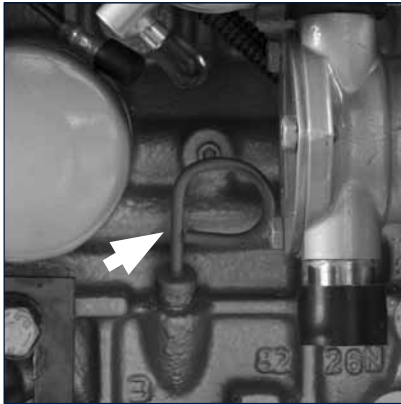

### Dipstick

In order to verify the level of lubricating oil, the engine must be stopped and cooled down.

The dipstick is located at the right side (seen from the rear) of the engine, in between the oil filter and the raw water pump.

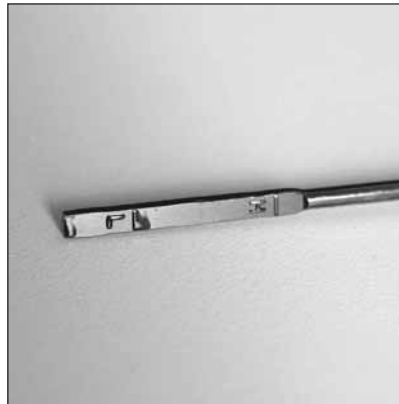

### Oil level

The markings on the dipstick indicate the upper and the lower limit of the oil level. The correct oil level is spot-on or close to the upper mark. If the engine has not enough oil, fresh oil of the same specifications must be added. The difference between the upper and the lower mark is about 2 liters of oil.



Make sure that no oil is added above the upper mark of the dipstick.

Any lubricating oil in excess will be burnt in the cylinders, causing black smoke from the exhaust and strong internal pollution of the engine.



### Topping up the lubrication oil

The filler cap is located on top of the rocker cover at the front of the engine; at the right side of the engine there is another filling entry.



Do not spill oil over the engine; better use a funnel when adding oil.

## 6 Maintenance and inspection



### Check-up of coolant level

Always verify the level of the cooling fluid when the engine is cold. Open the filler cap on the expansion tank (if fitted) or else the filler cap on top of the housing of the heat exchanger and make sure that the coolant level is about 1 cm below the bottom of the filler pipe.

If so required, top up with fresh cooling liquid (see page 39)

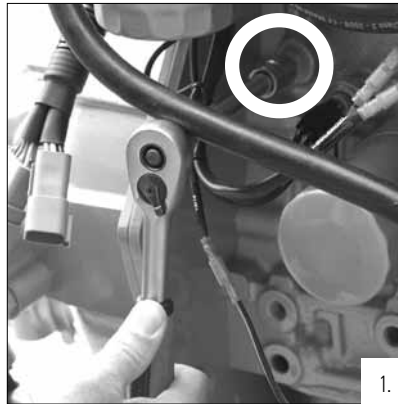

### Replace cooling liquid

Remove the two drain plugs of the cooling system from the engine block (1) and the housing of the heat exchanger (2). Remove the filler cap from the expansion tank (and/or the heat exchanger housing), in order to quickly drain the liquid from the internal cooling circuit and to make sure that all of the liquid has been discharged from the engine.

Replace the drain plugs and tighten them well. The inner cooling circuit is filled through the filler cap on top of the heat exchanger housing or, as the case may be, of the expansion tank.

Before filling in the fresh coolant, remove as well the bolt on top of the cover of the thermostat housing. This enables the cooling system to be vented (air-bled).

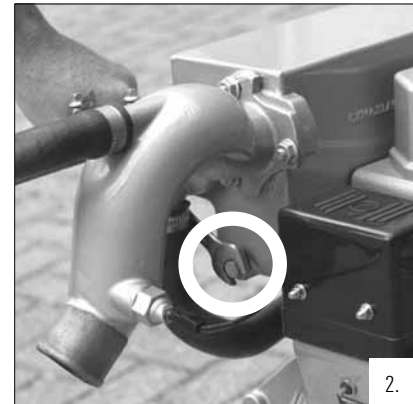

Fill the system with a mixture of 40% of anti-freeze and 60% of clean tap water.

You may also use ready-made cooling liquid; see page 43 for the relevant specifications of the recommended coolant.

Top up to a level of about 1 cm below the bottom of the filler pipe. After the engine being commissioned for the first time, i.e. has warmed-up and cooled down completely thereafter, check again the coolant level and top up if necessary.



Open the filler cap on top of the heat exchanger housing only when the engine is cold.

Never add sea (or salt) water into the inner cooling circuit!

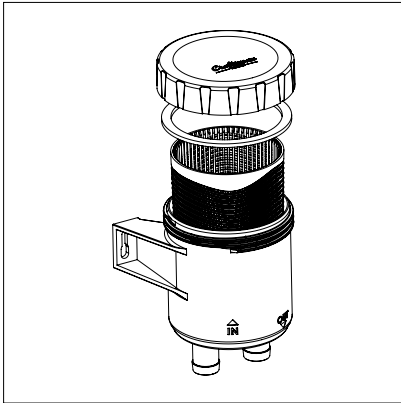

### Checking of the cooling water strainer

Each day, prior to starting the engine, make sure that the cooling water strainer is not clogged by dirt. Close the raw water seacock and remove the cover from the filter housing for proper inspection.

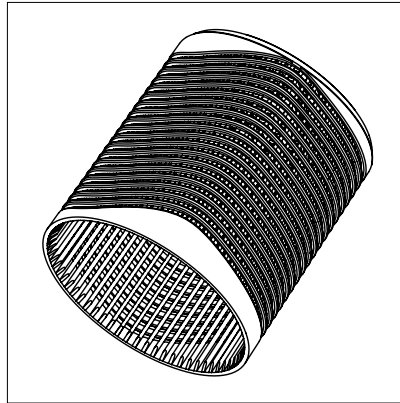

### Cleaning of the cooling water strainer

Clean the filter element at least twice a year, or whenever necessary. If the cooling water strainer gets clogged up, the cooling liquid in the engine may overheat.

When closing the strainer gain, make sure that the cover is perfectly shutting the unit off. If and when air is sucked into the system, on account of a badly closing filter cover, there is a severe risk of overheating of the engine.

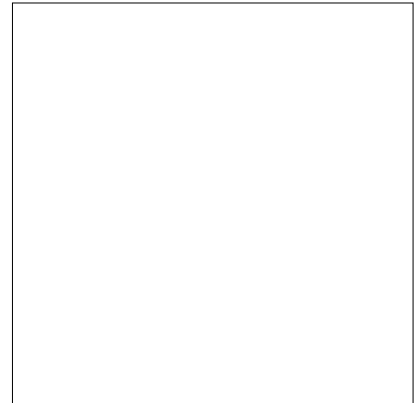

### Check once again!

Make absolutely sure that the cover fits the strainer housing well and without any air leaks!

## 6 Maintenance and inspection



### The fuel filter

#### After every 50 hours of service:

Replace the fuel filter, as described on page 26.



Consult the manual supplied with the product in question.



### Draining of the water separator

To drain the water separator:

- Open the drain plug at the bottom of the filter.
- Drain the water and collect it in a bowl; close the drain plug.



Note: a water separator does not belong to the standard scope of supply, but must be procured and fitted nonetheless.



#### Danger

Do not smoke when you drain liquids from engine or filters. Keep open fire away from the location. Remove any spilled oil or liquids before starting the engine.

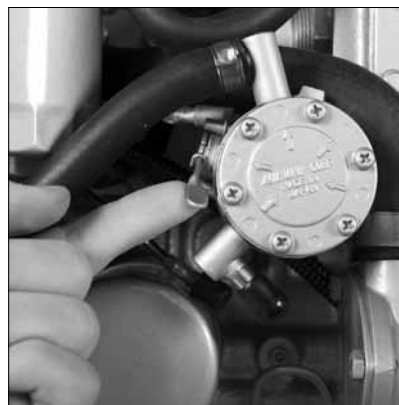

### Bleeding of the fuel system

After having drained the water separator/fuel filter, the fuel system must be freed from air ('bled').

Prime the fuel system by pumping the fuel pump manually (with handle). When all air has escaped close the bleeding nipples.

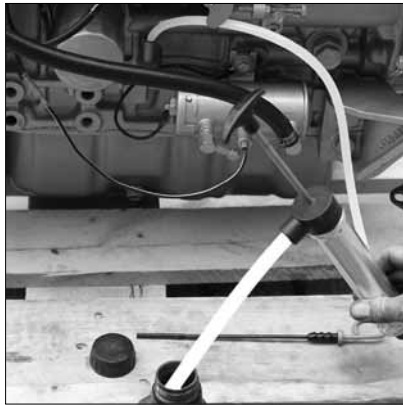

### Changing of the engine lubrication oil

Remove the dipstick first. Then insert the hose of the special sump pump into the pipe of the dipstick. Extract the oil from the engine by quickly pushing down the grip of the sump pump and then pull it slowly upwards.



### Fitting the oil filter

When all lubricating oil has been drained, replace the oil filter. A little more oil may then come out of the engine. Collect this oil in a beaker or bowl and bring it, with the rest of the used oil, to the service station, all in accordance with the environmental directives.



Replacing the oil must take place when the engine has its operating temperature (but is stopped, of course), so that the fluid can be pumped out easily. The oil temperature is then about 80 degrees Celsius, so watch out for burning the skin!

Replace the engine lubricant and the oil filter after every 100 hours of service or at least once a year.

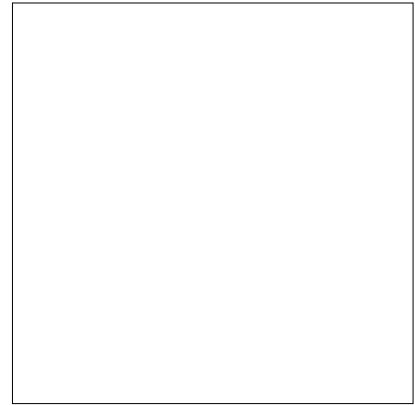

### Preparation of the new oil filter

Clean the surface of the rubber ring in the rim of the oil filter and grease it with fresh engine lubrication oil.

## 6 Maintenance and inspection

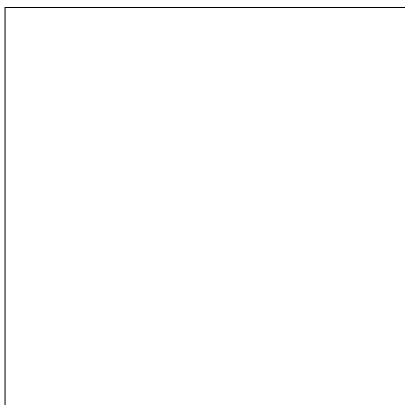

### Positioning of the oil filter

Turn the new oil filter onto the engine, thereby following the instructions given on the filter housing.

### Adding new oil filter

Fill the engine with lubrication oil with specifications as outlined on page 11 through one of both filling entries.

Use a funnel in order to avoid spilling of oil over the engine. Have the engine idling during a few moments and check after leaks.

Stop the engine and check the oil level by means of the dipstick, after about 5 minutes' time.





### Checking of oil level in gearbox

Remove the dipstick from the housing of the gearbox. Clean the dipstick and position it again into the opening, so as to verify the level of the lubricant.

If the level is too low, fresh lubricant must be added through the opening for the dipstick. See page 12 for the specifications of the lubrication oil for your gearbox.

As regards the maintenance of the gearbox, please consult the owner's manual, provided by the manufacturer in question.



### Draining the oil from the gearbox

First remove either the dipstick or the filler cap, dependent on the gearbox model. Position the hose of the special sump pump into the pipe of the dipstick. Extract the oil from the gearbox by quickly pushing down the grip of the sump pump and then pull it slowly upwards.

If there is sufficient space below the bottom of the gearbox, you may also remove the drain plug of the gearbox, for letting the oil out. In both cases collect the oil in a bowl and treat it in accordance with the environmental directives in your country.

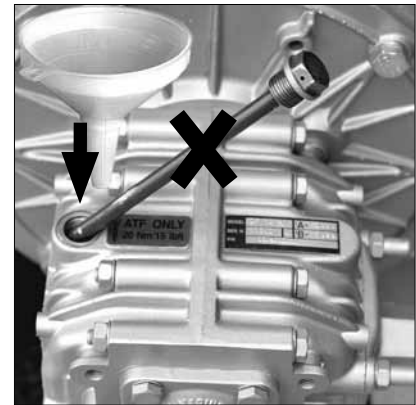

### Adding oil

Fill the gearbox with its lubricant through the hole of the dipstick, or via the filler cap, if available (dependent on the model of gearbox). Please consult the owner's manual, provided by the manufacturer in question.

## 6 Maintenance and inspection



### Remove the fuel filter

Close-off the fuel supply to the engine. Remove the entire filter with the aid of a special tool. It is possible that the filter still contains some fuel, which please collect and treat it in accordance with the environmental directives in your country.



Do not smoke when working at or around the fuel system and avoid open fire.



### Fit the fuel filter

Clean the surface to touch the engine before fitting the filter. Grease the rubber ring with clean engine oil. Fill the filter with clean diesel fuel. Position the filter against the filter housing and tighten it with one half to three quarters of a turn.

Clean the filter of the fuel lift pump and reopen the cock of the fuel supply.

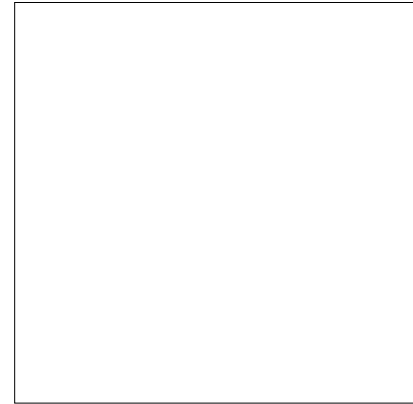

### Cleaning the filter of the fuel lift pump

Consult your dealer.

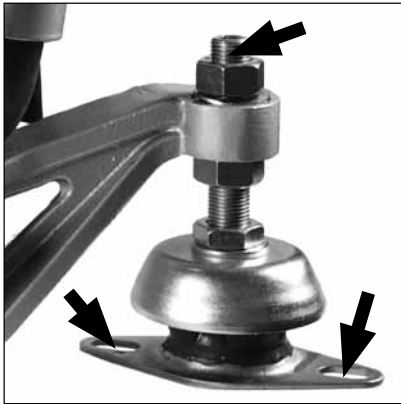

### Check the flexible engine mountings

Use a suitable tool to make sure that the bolts on the engine bed and the nuts on the spindle are securely tightened. The rubber element must not show any fissures.

Should this be the case, then the engine mounting must be replaced.



Make sure as well that the damper element is still sufficiently flexible. If not so, the engine must be realigned.

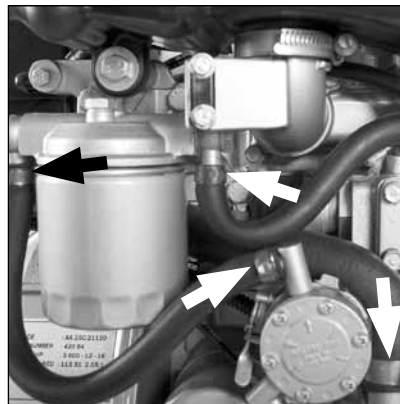

### Verify the hose connections

Inspect all hoses of the cooling system and of the fuel system. Check for loose connections or cracks and fissures in the rubber hoses. In such case the hose must be replaced.

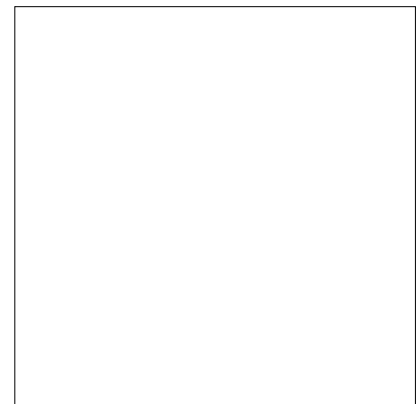

### Verify the fasteners

Make sure that all and sundry bolts, nuts and screws are well tightened.

## 6 Maintenance and inspection

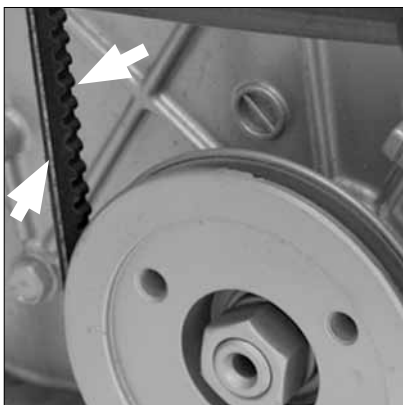

### Inspection of the V-belt

Check the V-belt for wear and tear, cracks and fissures and ravsels. In all of these cases the V-belt must be replaced. Only check the V-belt when the engine is not running.



### Verifying the tension of the V-belt

The tension of the V-belt is correct if it can be moved by no more than 12 mm, using thumb and forefinger and a force of about 10 kg. If the travel of the belt is greater, the tension must be adjusted.

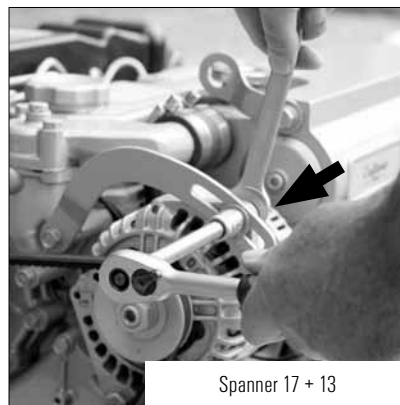

### Tensioning the V-belt

In order to tension the V-belt, the bolts of the support and both bolts of the alternator must be loosened. Tension the belt by pushing the alternator outward. Thereafter, first tighten the upper bolt of the alternator and thereafter the support and the lower bolt of the alternator.

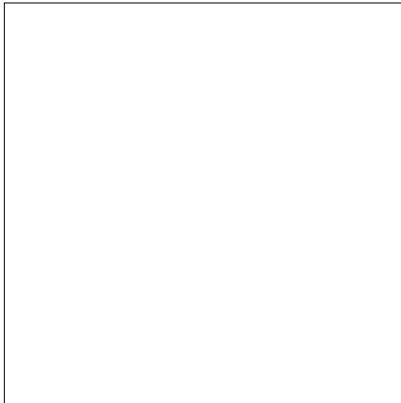

## Protective fuel mixture

So as to protect your engine well during the standstill of the winter season, it is recommended to have the engine running for some 10 minutes with a protective mixture of 10% lubrication oil and 90% of clean diesel fuel.



With this mixture: idling revolutions only, no revving up allowed!

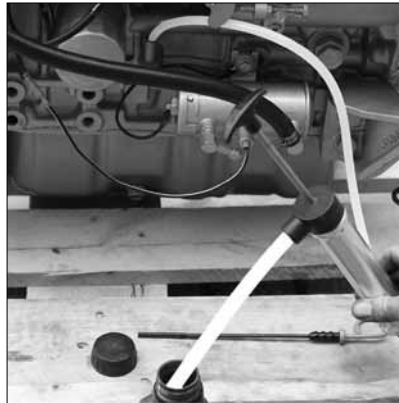

## Lubrication oil system

Replace the oil filter and change the engine lubrication oil with a good quality of oil, with protective properties. See page 23.

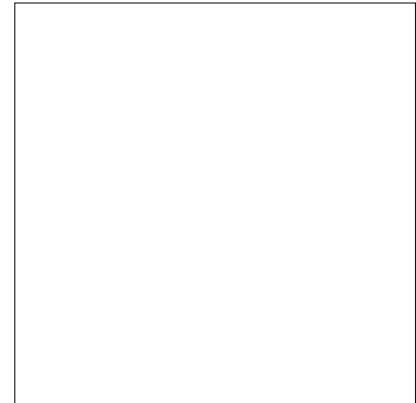

## Raw water cooling system

Close the raw water seacock and clean the raw water strainer. Drain so much cooling liquid from the inner cooling circuit, so as to enable you to add 1 liter of (extra) anti-freeze into the cooling circuit. Have the motor idling for a few seconds, so that the additional anti-freeze can be spread throughout the system.



Anti-freeze liquid is very poisonous !  
Make sure anti-freeze is not getting mixed up with raw water.

When closing the cover of the raw water strainer, make sure that it tightens well. If false air is coming into the system through a cover that is not closed tightly, there is a severe risk of overheating of the engine.

## 7 Winter storage

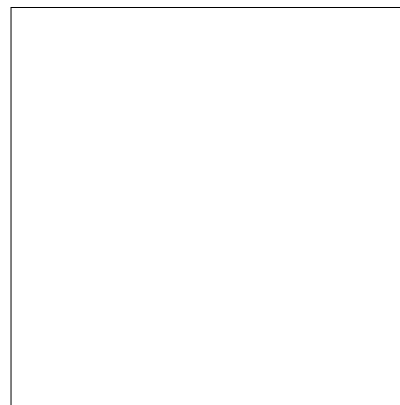
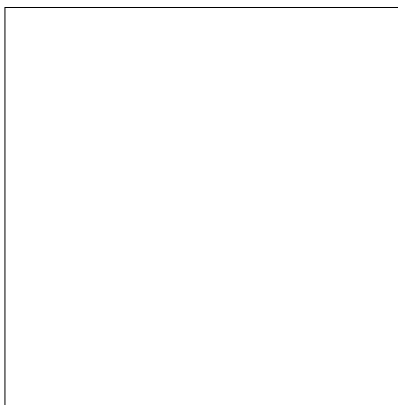

### Inner circuit of the cooling system

Make sure that the inner cooling system contains sufficient anti-freeze, in order to avoid corrosion. Check with the aid of a volume gauge. See page 39 for the relevant specifications. If it appears that there is not enough anti-freeze in the coolant, replace the liquid, as described on page 20.

### Electrical system

Disconnect the battery cables and charge the batteries from time to time, during the winter period.

### Filters

Drain the water from the fuel filter/water separator in order to avoid frost damage.

Fit a new fuel filter, see page 26.

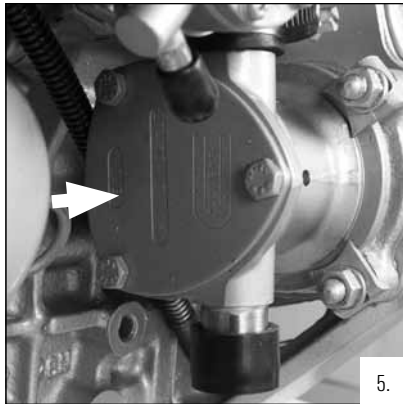

5.



8.

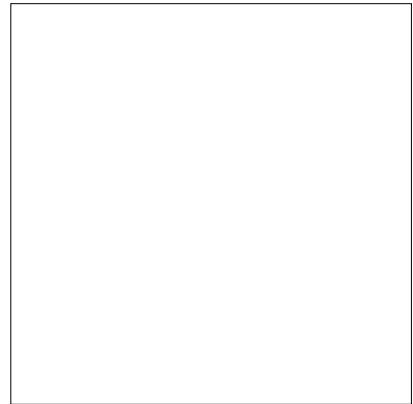

1. Open the fuel supply cock.
2. Charge the battery (ies), if necessary.
3. Connect the battery cables.
4. Verify that the cover of the raw water cooling strainer is tightened well
5. Verify the tightness of the raw water pump cover and of all drain plugs (see page 20).

6. If you have disconnected any hoses before winter storage, these must all be connected again and tightened well.
7. Open the seacock of the raw water entry.
8. Check the level of the cooling liquid, as described on page 20.
9. Make sure that the engine has sufficient lubrication oil, as described on page 11.

10. Start the engine and make sure that there are no leaks in the fuel system, the cooling system and the exhaust assembly.
11. Verify the proper functioning of all electronic parts and all engine instruments. Also verify the proper functioning of the mechanical remote control and the gearbox.

## 9 Problems and solutions

Problem	Probable cause	Solution
<p><b>1. Starter motor does neither rotate nor engage</b></p>	<ul style="list-style-type: none"> <li>• Defective or discharged battery</li> <li>• Burnt fuse</li> <li>• Loose or corroded connections in the starter circuit</li> <li>• Defective starter switch or relay</li> <li>• Defective starter motor or pinion does not engage</li> <li>• Starter relay not activated owing to insufficient voltage, on account of a too long cable from engine to instrument panel</li> <li>• Jammed components</li> </ul>	<ul style="list-style-type: none"> <li>• Check battery/charge or replace and check alternator for proper functioning</li> <li>• Replace</li> <li>• Clean and tighten the connections</li> <li>• Replace defective component</li> <li>• Replace starter motor Fit an auxiliary starter relay</li> <li>• Repair</li> </ul>
<p><b>2. Starter motor turns round, but engine does not respond</b></p>	<ul style="list-style-type: none"> <li>• Fuel valve closed</li> <li>• Empty fuel tank</li> <li>• Air in fuel system</li> <li>• Fuel filter clogged up by water or dirt</li> <li>• Leak in fuel supply or fuel injection line(s)</li> <li>• Defective injector / injection pump</li> <li>• Breather line of fuel tank clogged up</li> <li>• Clogging in exhaust line</li> <li>• Electrical fuel lift pump defective</li> <li>• Dirt in press or suction valves of the electric fuel lift pump</li> <li>• Filter of electrical fuel lift pump is clogged up</li> </ul>	<ul style="list-style-type: none"> <li>• Open</li> <li>• Fill</li> <li>• Check /breathe</li> <li>• Check/replace</li> <li>• Check/replace</li> <li>• Check and replace if necessary</li> <li>• Check/clean</li> <li>• Check</li> <li>• Check/clean</li> <li>• Replace. Moreover, position a water separator/fuel filter into the fuel line between tank and engine</li> <li>• Check/clean</li> </ul>
<p><b>3. Starter motor turns round, but engine does not respond; smoke comes from exhaust</b></p>	<ul style="list-style-type: none"> <li>• Air in the fuel system</li> <li>• Defective injector/injection pump</li> <li>• Setting of stop valve incorrect</li> <li>• Defective glow plugs</li> <li>• Incorrect valve tolerance</li> <li>• After engine overhaul, incorrect injection moment</li> <li>• Insufficient combustion air</li> <li>• Poor fuel quality or polluted fuel</li> <li>• Incorrect SAE-specification or quality of lubricant</li> </ul>	<ul style="list-style-type: none"> <li>• Check / bleed the system</li> <li>• Check / replace if necessary</li> <li>• Check / readjust</li> <li>• Check / replace</li> <li>• Read just</li> <li>• Check / readjust</li> <li>• Check air intaker and remove blockage</li> <li>• Check fuel quality. Drain fuel tank and rinse it well. Fill with good quality fuel</li> <li>• Replace by good quality lubrication oil</li> </ul>



Problem	Probable cause	Solution
<p><b>4. Engine starts running but with irregular cycles or it stops again</b></p>	<ul style="list-style-type: none"> <li>• Empty fuel tank</li> <li>• Air in the fuel system</li> <li>• Fuel filter clogged up with water and/or dirt</li> <li>• Leaking fuel supply or fuel injection line</li> <li>• Defective injector/injection pump</li> <li>• Breather line of fuel tank clogged up</li> <li>• Fuel line clogged</li> <li>• Incorrect valve clearance</li> <li>• Idling revolutions too low</li> <li>• Exhaust clogged up</li> <li>• Poor fuel quality or polluted fuel</li> <li>• Filter of electrical fuel lift pump is clogged</li> </ul>	<ul style="list-style-type: none"> <li>• Fill it</li> <li>• Check / bleed the system</li> <li>• Check / clean or replace</li> <li>• Check and replace, if necessary</li> <li>• Check and clean or replace</li> <li>• Check /remove blockage</li> <li>• Check / remove blockage</li> <li>• Readjust</li> <li>• Readjust</li> <li>• Check / remove blockage</li> <li>• Check fuel quality. Drain fuel tank and rinse it well. Fill with good quality fuel</li> <li>• Check / clean</li> </ul>
<p><b>5. Engine does not arrive at maximum revolutions under full load</b></p>	<ul style="list-style-type: none"> <li>• Air in the fuel system</li> <li>• Fuel filter clogged up with water and/or dirt</li> <li>• Leakage in fuel supply line or fuel injection line</li> <li>• Setting of stop valve incorrect</li> <li>• Oil level too high</li> <li>• Incorrect SAE-specification or quality of lubrication oil</li> <li>• Incorrect valve clearance</li> <li>• Clogging in the exhaust</li> <li>• Insufficient quantity of combustion air</li> <li>• Poor fuel quality or polluted fuel</li> <li>• Incorrect injection moment</li> <li>• Leakage of air intake manifold</li> <li>• Engine overload</li> </ul>	<ul style="list-style-type: none"> <li>• Check and bleed the system</li> <li>• Clean or replace</li> <li>• Check and replace, if necessary</li> <li>• Check / reset</li> <li>• Drain sufficient oil quantity</li> <li>• Replace by engine lubrication oil of good quality</li> <li>• Adjust</li> <li>• Check / remove clogging</li> <li>• Check air inlet and ventilation openings in engine room</li> <li>• Check fuel quality. Drain fuel tank and rinse it well. Fill with good quality fuel</li> <li>• Check / readjust</li> <li>• Replace manifold</li> <li>• Check dimensions of boat propeller</li> </ul>

## 9 Problems and solutions

Problem	Probable cause	Solution
<b>6. Engine becomes overheated</b>	<ul style="list-style-type: none"> <li>• Level of cooling liquid too low</li> <li>• Raw water seacock closed</li> <li>• Raw water strainer clogged</li> <li>• Leakage in raw water entry system</li> <li>• Defective thermostat</li> <li>• Cooling liquid pump defective</li> <li>• Defective impeller of raw water pump</li> <li>• Defective injector / injector pump</li> <li>• Oil level too high</li> <li>• Oil level too low</li> <li>• Defective oil filter</li> </ul>	<ul style="list-style-type: none"> <li>• Check/top up</li> <li>• Check and open</li> <li>• Check / clean</li> <li>• Check/ replace</li> <li>• Check / replace</li> <li>• Check / replace</li> <li>• Check / replace</li> <li>• Check and clean or replace if necessary</li> <li>• Lower oil level</li> <li>• Top up / Replace</li> </ul>
<b>7. Not all cylinders are performing well</b>	<ul style="list-style-type: none"> <li>• Air in the fuel system</li> <li>• Fuel filter clogged up by water and/or dirt</li> <li>• Leakage in fuel supply line or fuel injection line</li> <li>• Defective injector / injection pump</li> <li>• Fuel line clogged</li> <li>• Defective glow plugs</li> <li>• Incorrect valve tolerance</li> <li>• Filter of electrical fuel lift pump clogged</li> <li>• Defective electrical fuel lift pump</li> </ul>	<ul style="list-style-type: none"> <li>• In all these cases, please consult your authorized dealer and ask him to solve the problem</li> </ul>
<b>8. Engine has little or no oil pressure</b>	<ul style="list-style-type: none"> <li>• Oil level too low</li> <li>• Clogged oil filter</li> <li>• Defective oil pump</li> <li>• Excessive inclination angle of engine</li> <li>• Incorrect SAE-specification or quality of lubrication oil</li> <li>• Oil pressure apparently too low on account of defective oil pressure switch, sensor or gauge</li> </ul>	<ul style="list-style-type: none"> <li>• To up till correct oil level</li> <li>• Replace</li> <li>• Repair / replace</li> <li>• Check / adjust alignment</li> <li>• Replace by good quality engine lubricating oil</li> <li>• Replace defective component</li> </ul>
<b>9. Engine oil consumption excessively</b>	<ul style="list-style-type: none"> <li>• Oil level too high</li> <li>• Excessive inclination angle of engine</li> <li>• Incorrect SAE-specification or quality of lubrication oil</li> <li>• Leakage in lubrication oil system</li> <li>• Excessive wear and tear to cylinder or piston</li> <li>• Insufficient supply of combustion air</li> <li>• Overload of engine</li> </ul>	<ul style="list-style-type: none"> <li>• Lower the oil level</li> <li>• Check / adjust alignment</li> <li>• Replace by good quality lubricating oil</li> <li>• Repair / replace</li> <li>• Check compression; overhaul engine, if needed</li> <li>• Check air inlet and ventilation openings in engine room</li> <li>• Check the dimensions of the boat propeller</li> </ul>

Problem	Probable cause	Solution
<p><b>10. Excessive fuel consumption of engine</b></p>	<ul style="list-style-type: none"> <li>• Poor or polluted fuel quality</li> <li>• Defective injector / injection pump</li> <li>• Incorrect injection moment</li> <li>• Excessive wear and tear of cylinder / piston</li> <li>• Insufficient supply of combustion air</li> </ul>	<ul style="list-style-type: none"> <li>• Check fuel quality. Drain fuel tank and rinse it well. Fill with good quality fuel</li> <li>• Check and replace if necessary</li> <li>• Check / adjust</li> <li>• Check compression, overhaul engine if necessary</li> <li>• Check the air intake and the ventilation openings in the engine room</li> </ul>
<p><b>11. Blue smoke coming out of the exhaust (when idling)</b></p>	<ul style="list-style-type: none"> <li>• Oil level too high</li> <li>• Excessive inclination angle of the engine</li> <li>• Leaking oil seal of the turbo compressor</li> </ul>	<ul style="list-style-type: none"> <li>• Lower oil level</li> <li>• Check / adjust alignment of engine</li> <li>• Check / replace</li> </ul>
<p><b>12. Black smoke coming out of the exhaust (under load)</b></p>	<ul style="list-style-type: none"> <li>• Defective turbocompressor</li> <li>• Insufficient supply of combustion air</li> <li>• Leakage in air intake manifold</li> <li>• Defective injector / injection pump</li> <li>• Incorrect injection moment</li> <li>• Incorrect valve clearance</li> <li>• Excessive wear and tear of cylinder / piston</li> <li>• Engine overheated, does not reach maximum rpm</li> </ul>	<ul style="list-style-type: none"> <li>• Check air intake as well as the ventilation openings in the engine room</li> <li>• Check/ replace</li> <li>• Check/ replace</li> <li>• Check and replace when necessary</li> <li>• Check/readjust</li> <li>• Readjust</li> <li>• Check compression, overhaul the engine if needed</li> <li>• Check the dimensions (diameter and pitch) of the propeller and replace the propeller if necessary.</li> </ul>
<p><b>13. Engine produces white smoke from the exhaust (at full load)</b></p>	<ul style="list-style-type: none"> <li>• Air inclusion in the fuel system</li> <li>• Defective injector / injection pump</li> <li>• Water in the fuel system</li> <li>• Defective pre-heating plugs</li> <li>• Incorrect valve clearance</li> <li>• Incorrect injection moment</li> <li>• Poor fuel quality or polluted fuel</li> <li>• Condensation of vapour in the exhaust system, on account of very low ambient temperature</li> </ul>	<ul style="list-style-type: none"> <li>• Check / bleed the system</li> <li>• Check / replace if necessary</li> <li>• Check / replace water separator / fuel filter</li> <li>• Check / replace</li> <li>• Check / adjust</li> <li>• Check / adjust</li> <li>• Check fuel quality. Drain fuel tank and rinse it well. Fill with good quality fuel</li> <li>• No problem, no danger</li> </ul>

## 10 Technical data

### General specifications

#### Basic engine:

Bore x stroke:

Capacity:

Number of cylinders:

Compression ratio:

Order of fuel injection:

Maximum number of revolutions:

Maximum torque:

Maximum output at flywheel:

Fuel consumption at 1800 rpm:

Exhaust diameter:

Weight:

Type of engine		
	CM2.16	CM3.27
	Mitsubishi	Mitsubishi
Bore x stroke:	76 x 70 mm	76 x 70 mm
Capacity:	635 cm <sup>3</sup>	952 cm <sup>3</sup>
Number of cylinders:	2 in line	3 in line
Compression ratio:	23 : 1	22 : 1
Order of fuel injection:	IDI (indirect)	IDI (indirect)
Maximum number of revolutions:	3600 rpm	3600 rpm
Maximum torque:	29,3 Nm at 3600 rpm	53,1 Nm at 3600 rpm
Maximum output at flywheel:	11,8 kW/16 pk (ISO 8665/3046)	20 kW/27.2 pk (ISO 8665/3046)
Fuel consumption at 1800 rpm:	268 g/kW.h (196 g/pk.h)	270 g/kW.h (199 g/pk.h)
Exhaust diameter:	Ø 40	Ø 40
Weight:	90 kg	113 kg

**General specifications:**

Type of engine		
	CM2.16	CM3.27
Gearbox:	no	no
Electric circuit protection:	automatic	automatic
Alternator:	12 Volt, 75 A	12 Volt, 75 A
Warning functions in instrument panel:	Oil pressure, Temperature of coolant inner circuit, Charging current, Exhaust temperature, Pre-heating	Oil pressure, Temperature of coolant inner circuit, Charging current, Exhaust temperature, Pre-heating
Instrument panel:	Alfa 10E	Alfa 20E
Connections for calorifier (boiler):	optional	optional
Cooling system:	Dual circuit with heat exchanger	Dual circuit with heat exchanger
Flexible engine mountings:	CM type 2	CM type 3

## 11 Lubricants and cooling liquids

### Viscosity

Viscosity means that a liquid is "syrupy" and in this case it applies to lubricating oil. The viscosity is largely dependent on the ambient temperature and is expressed in terms of an SAE-standard.

### Engine oil

Always use a type of oil that suits the environment in which the engine operates. We recommend the use of a 'four seasons' engine lubricant, branded SAE 15 W/40, which is suitable for ambient temperatures of between -15 °C and +35 °C.

It is strongly recommended to use a type of engine lubrication oil made by a well-known manufacturer, with the following classifications:

**Type: 15W40**

**API: CD, CE of CF4**

**CCMC: D4 of D5**

### Oil lubrication system

Oil capacity, maximum 2.4 litres (without oil filter) , maximum 2.9 litres with oil filter (CM2.16).

Oil capacity, maximum 3.6 litres (without oil filter) , maximum 4.1 litres with oil filter (CM3.27).

### Cooling system

Capacity with inter cooler version, 2.2 litres, with keel cooler version 3 litres (CM2.16).

Capacity with inter cooler version, 3 litres, with keel cooler version 4 litres (CM3.27).

### Lubrication oil in gearbox

Also in this case a lubricant of a well-known and trusted brand is highly recommended.

#### ZF Hurth:

Type ZF10 : 0,35 liter ATF\*

Type ZF12: 1,1 liter ATF\*

#### Technodrive:

Type TMC40: 0,20 liter,

Engine lubricating oil SAE 20/30

Type TMC40M: 0,20 liter ATF\*

Type TMC60: 0,80 liter,

Engine lubricating oil SAE 20/30

\*ATF: Automatic Transmission Fluid

## Fuel (summer period)

Always use a good diesel fuel with sulphur contents of less than 0,5%. The maximum admissible sulphur percentage is 1%.

Following fuel specifications may be used:

CEN EN 590 or DIN/EN 590  
 DIN 51 601 (Febr. 1986)  
 BS 2869 (1988) : A1 and A2  
 ASTM D975 - 88: D1 and D2  
 NATO Code F-54 and F-75

## Fuel (winter period)

During the winter season clogging-up of the fuel system may occur and cause engine failure, on account of separation of the paraffin content in the fuel.

Please use a winter type fuel (suitable up to -15 °C) when the ambient temperature is less than zero degrees Celsius, or a diesel fuel with additives (suitable up to -20 °C) .

## Cooling liquid

Always use a mixture of anti-freeze on the basis of ethylene-glycol and clean tap water.

**Table of anti-freeze concentration used for engine coolant**

Anti-freeze (ethylene-glycol)	Water	Protection against freezing up to
Maximum 45 %	55%	-35 C°
40%	60%	-28 C°
Minimum 35 vol%	65%	-22 C°

## 12 Overall Dimensions

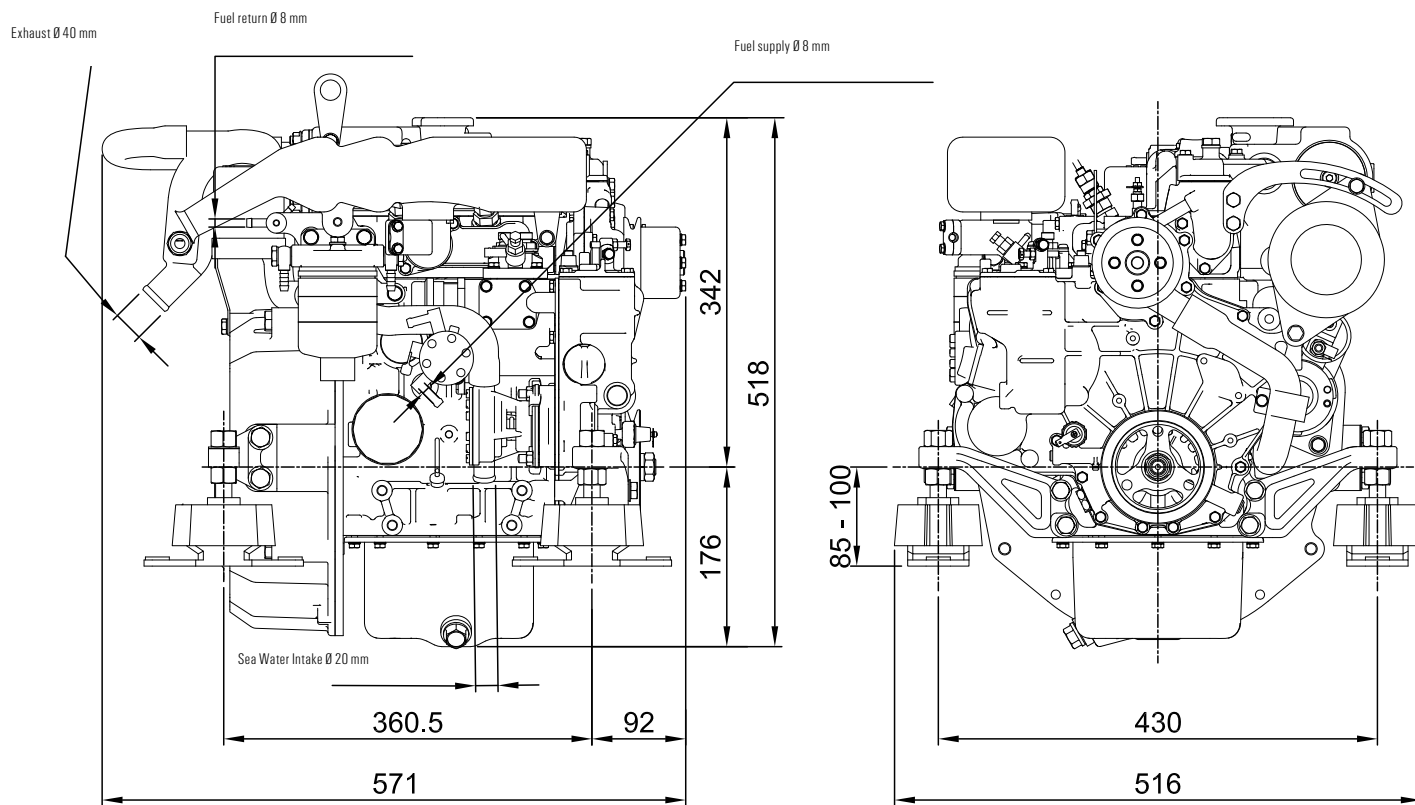



## Overall Dimensions 12

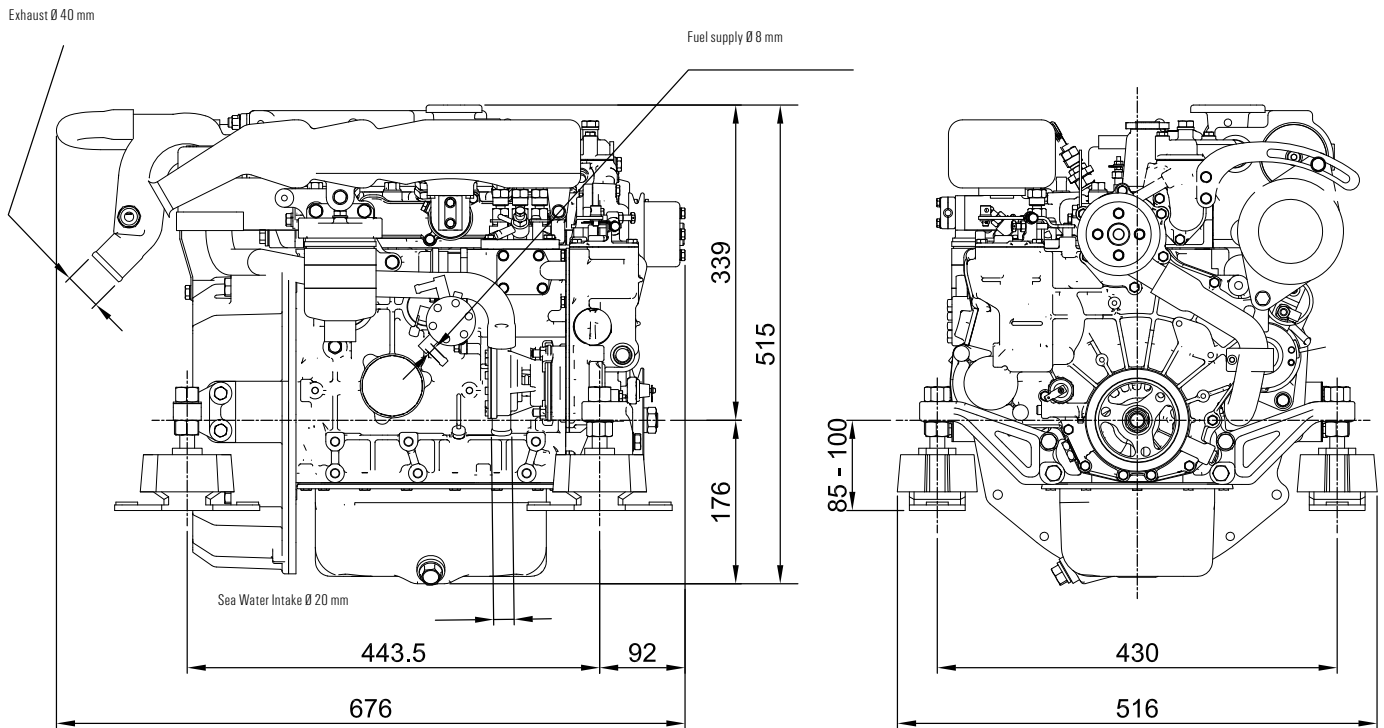

**Notes**

A series of horizontal dotted lines for writing notes, arranged in two columns.



[info@craftsmanmarine.com](mailto:info@craftsmanmarine.com)  
[www.craftsmanmarine.com](http://www.craftsmanmarine.com)

ZD-010.004.2.1.07.10

**CRAFTED WITH CRAFTSMAN MARINE**